

# Data Sheet

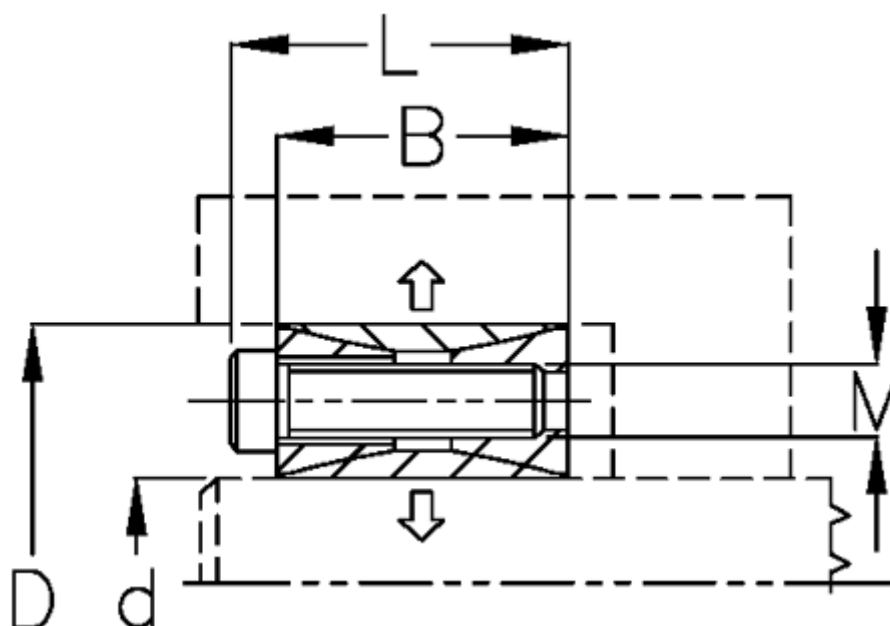

Article number: 432000130  
Description: Rota-fix shaft-hub connection A 130x180  
Steel  
Note: Not self centering. Medium-high torques.

## Measures



B mm	= 38
d H8 mm	= 130180
D mm	= 180
Fit tolerance	= Aksel k11-h11, Nav N11-H11
F kN torque	= 310.0
L mm	= 44
M mm	= M12
P N/mm <sup>2</sup> surface pressure on shaft/hub	= 134

Surface roughness	=
T N m torque	=
Ts N m bolt tightening torque	=